

Installation and Operations Manual

Please read the following information before installing. A visual inspection of this product for damage during shipping is recommended before mounting. It is your responsibility to have a qualified person install this unit.

GENERAL INFORMATION

WARNING

BEFORE BEGINNING INSTALLATION OF THIS MURPHY PRODUCT

- ✓ Disconnect all electrical power to the machine.
- ✓ Make sure the machine cannot operate during installation.
- ✓ Follow all safety warnings of the machine manufacturer.
- ✓ Read and follow all installation instructions.



Description

The PowerView is a powerful new display in a line of components manufactured by FWMurphy as part of its J1939 MurphyLink™† Family. The J1939 MurphyLink™ Family of products have been developed to meet the needs for instrumentation and control on electronically controlled engines communicating using the SAE J1939 Controller Area Network (CAN).

The PowerView System is comprised of the PowerView and the Mlink™ PowerView Gages. The PowerView is a multifunction tool that enables equipment operators to view many different engine or transmission parameters and service codes. The system provides a window into modern electronic engines and transmissions. The PowerView includes a graphical backlit LCD screen. It has excellent contrast and viewing from all angles. Back lighting can be controlled via menu or external dimmer potentiometer. The display can show either a single parameter or a quadrant display showing 4 parameters simultaneously. Diagnostic capabilities include fault codes with text translation for the most common fault conditions.

The PowerView has four buttons using self-calibrating charge transfer activation technology, which eliminates the concern for pushbutton wear and failure. In addition operators can navigate the display with ease. Enhanced alarm indication with ultra bright alarm and shutdown LEDs (amber & red). It has a wide operating temperature range of -40 to +85° C (-40 to 185° F), display viewing -40 to +75° C (-40 to 167° F), and increased environmental sealing to +/- 5 PSI (± 34kPa). In addition it features Deutsch DT style connectors molded into the case and fits quickly and easily into existing 2-1/16 in. (52 mm) gage opening with little effort.

Other components in the system are microprocessor-based Mlink™ PowerView Gages for displaying critical engine data broadcast by an electronic engine or transmission's Engine Control Unit (ECU): engine RPM, oil pressure, coolant temperature, system voltage, etc. and a combination audible alarm and relay unit for warning and shutdown annunciation. Up to 32 components may be linked to the PowerView using a simple daisy chain wire connection scheme using RS485. The PowerView and all connected components can be powered by 12 or 24-volt systems.

Display Parameters

The following are some of the engine and transmission parameters displayed by the PowerView in English or Metric units (when applicable, consult engine or transmission manufacturer for SAE J939 supported parameters):

- ❖ Engine RPM
- ❖ Engine Hours
- ❖ Machine Hours
- ❖ System Voltage
- ❖ % Engine Load at the current RPM
- ❖ Coolant Temperature
- ❖ Oil Pressure
- ❖ Fuel Economy
- ❖ Throttle Position
- ❖ Engine Manifold Air Temperature
- ❖ Current Fuel Consumption
- ❖ Transmission Gear Oil Pressure
- ❖ Transmission Gear Oil Temperature
- ❖ Transmission Gear Position
- ❖ Active Service Codes
- ❖ Stored Service Codes from the engine
- ❖ Set Units for display (English or Metric)
- ❖ Engine Configuration Parameters

Warranty

A limited warranty on materials and workmanship is given with this FWMurphy product.

A copy of the warranty may be viewed or printed by going to www.fwmurphy.com/warranty.asp.

† MurphyLink™ is a registered trademark of FWMurphy. All other trademarks and service marks used in this document are the property of their respective owners.

Table of Contents

General Information	<i>page #</i>
Warnings.....	1
Description.....	1
Display Parameters.....	1
General Information (continued)	
Table of Contents.....	2
Key Pad Functions.....	2
Mechanical Installation	
Specifications.....	3
Typical Mounting Dimensions.....	3
Typical Quick-connect Diagram.....	3
Electrical Installation	
PIN Connectors Nomenclature.....	4
Typical Wiring Diagram.....	4
Operations	
First Time Start Up.....	5
Main Menu Navigation.....	5
Stored Fault Codes.....	6
Engine Configuration Data.....	6
Faults and Warnings.....	7
Active Fault Codes.....	8
Shutdown Codes.....	8
Back Light Adjustment.....	9
Contrast Adjustment.....	10
Select Units.....	10
Setup 1-Up Display.....	11
Setup 4-Up Display.....	14
Utilities.....	15
J1939 Parameters.....	16
Glossary.....	17



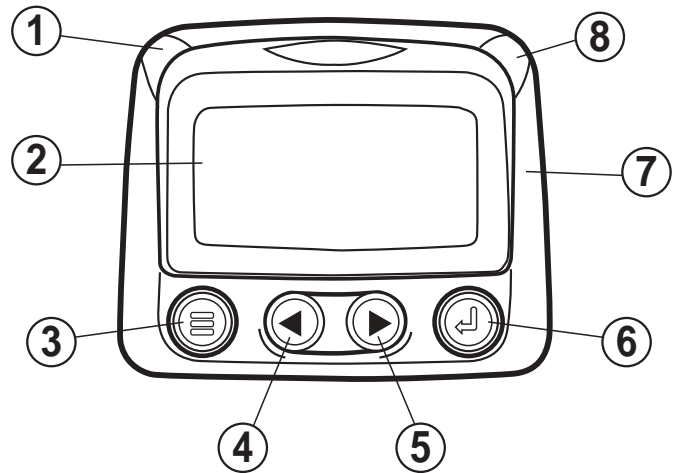

Key Pad Functions

- 1. Amber Warning LED**
- 2. Display**
- 3. Menu Key**
- 4. Left Arrow Key**
- 5. Right Arrow Key**
- 6. Enter Key**
- 7. Bezel**
- 8. Red Shutdown/Derate LED**



Keypad Functions

The keypad on the PowerView is a capacitive touch sensing system. There are no mechanical switches to wear or stick, and the technology has been time proven in many applications. It operates in extreme temperatures, with gloves, through ice, snow, mud, grease, etc., and it allows complete sealing of the front of the PowerView. The 'key is pressed' feedback is provided by flashing the screen. The keys on the keypad perform the following functions:

- 
– **Menu Key** - The Menu Key is pressed to either enter or exit the menu screens.
- 
– **Left Arrow** - The Left Arrow Key is pressed to scroll through the screen either moving the parameter selection toward the left or downward.
- 
– **Right Arrow** - The Right Arrow Key is pressed to scroll through the screen either moving the parameter selection toward the right or upward.
- 
– **Enter Key** - The Enter Key (also known as Enter Button) is pressed to select the parameter that is highlighted on the screen.

MECHANICAL INSTALLATION

Specifications

Display: 1.3 x 2.6 in. (33 x 66 mm), 64 x 128 pixels.

Operating Voltage: 8 VDC minimum to 32 VDC max.

Reversed Polarity: Withstands reversed battery terminal polarity indefinitely within operating temperatures.

Operating Temperature: -40 to +85°C (-40 to 185°F).

Display Viewing Temperature: -40 to +75°C (-40 to 167°F).

Storage Temperature: -40 to +85°C (-40 to 185°F).

Environmental Sealing: IP68, +/- 5 PSI (+/- 34.4 kPa).

Power Supply Operating Current: (@ 14 VDC)= 52 mA minimum; 268 mA maximum (LCD heater on).

CAN BUS: SAE J1939 Compliant.

Case: Polycarbonate / Polyester.

Clamp: Polyester (PBT).

Connectors: 6-Pin Deutsch DTO6 Series.

Maximum Panel Thickness: 3/8 in. (9.6 mm).

Mounting Hole: 2.062 inch (52 mm) in diameter.

Auxiliary Communications (Gages):

One (1) RS485 port, MODBUS RTU master, 38.4K baud, N, 8, 1 or 2, half duplex.

Potentiometer Input: 1K ohm, 1/4 W

Shipping Weights (all models): 1 lb. (450 g.)

Shipping Dimensions (all models): 6 x 6 x 6 in. (152 x 152 x 152 mm).

Typical Mounting Dimensions

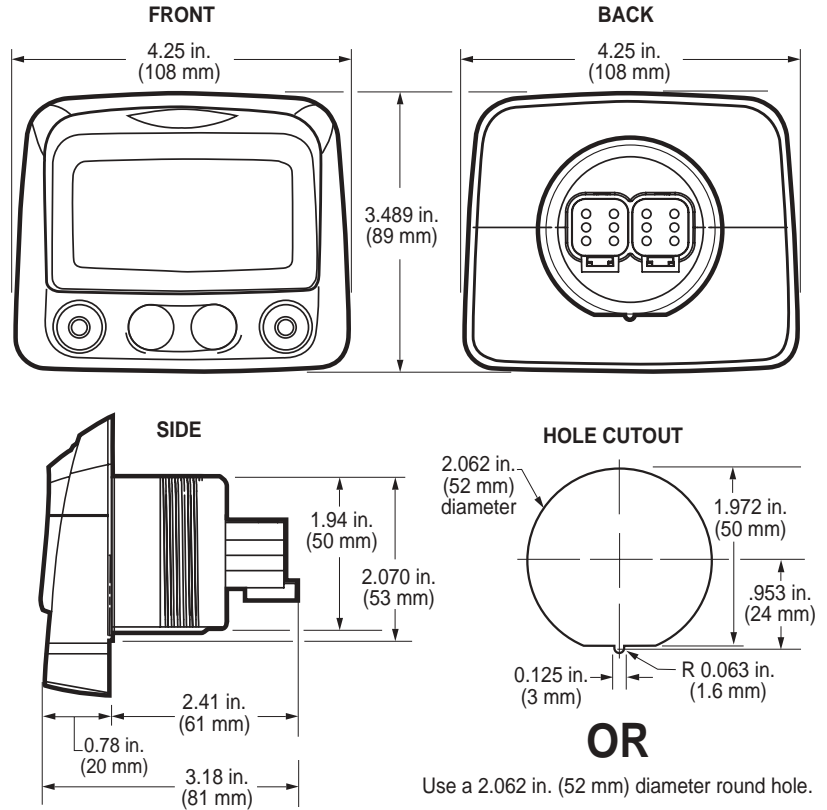

Typical Quick-Connect Diagram

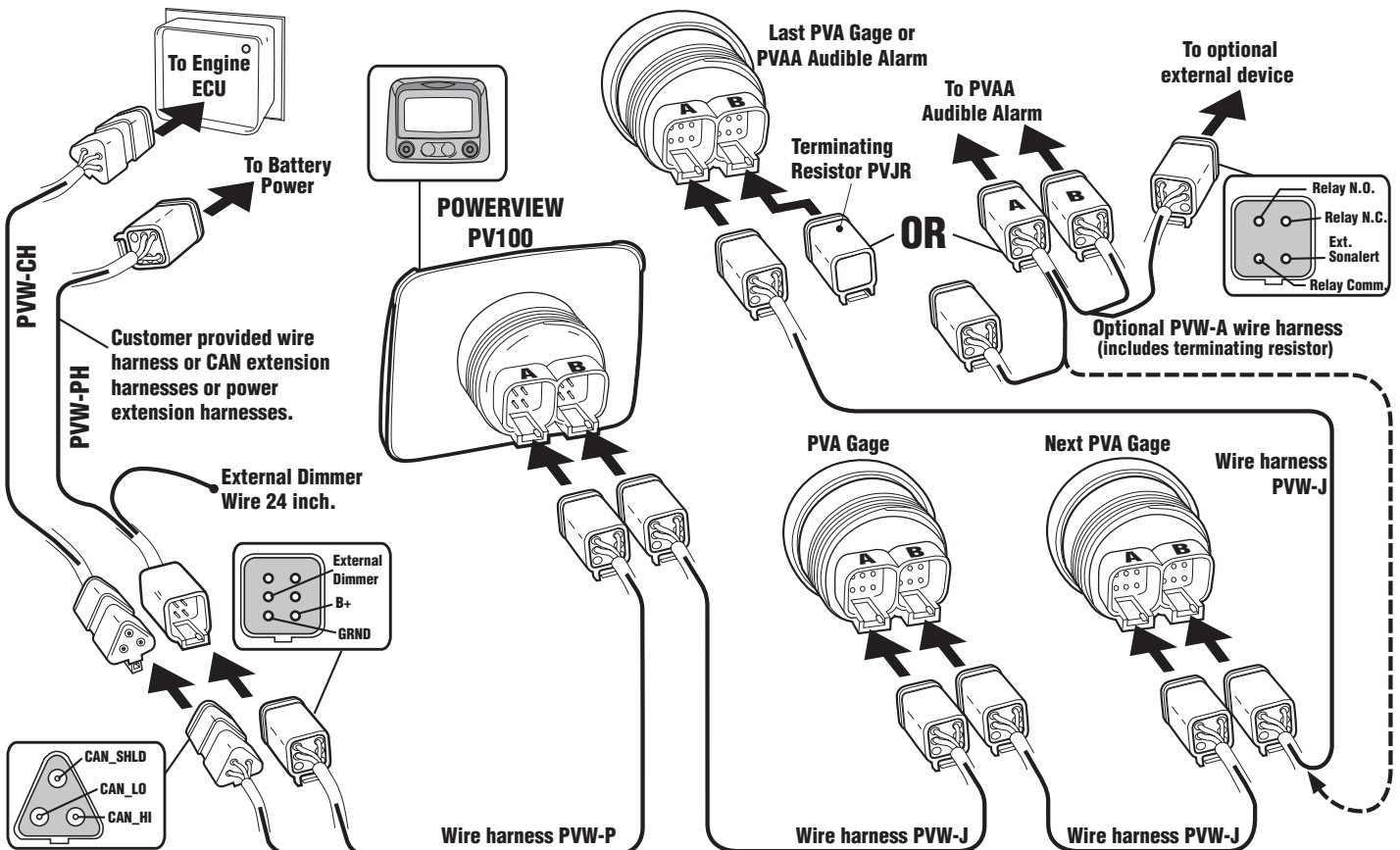

ELECTRICAL INSTALLATION

PowerView Unit Back View Deutsch DT06-6S Style Connections

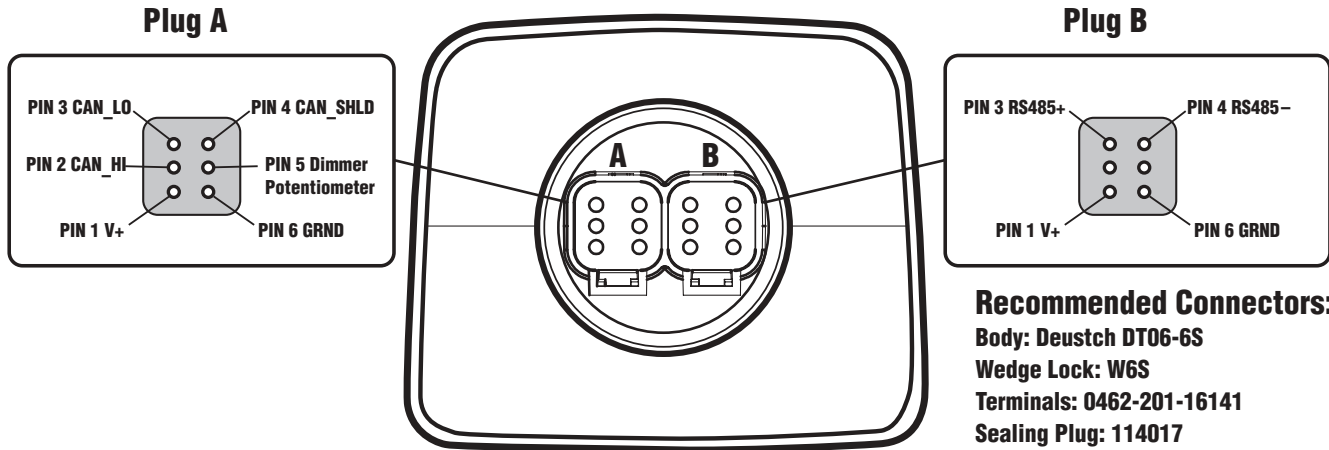

Typical Wiring Diagram

IMPORTANT: To eliminate external interference: RS485(+) and RS485(-) should be twisted pair cable or twist wires together, one twist per inch minimum. CAN_L, CAN_H and CAN Shield should be approved J1939 CAN bus cable (CAN wire for example: RADOX plug and play cable, from Champlain cable). (RS485 wire for example: BELDEN 9841 or 3105A).

PowerView Deutsch DT06-6S Style Unit Back View

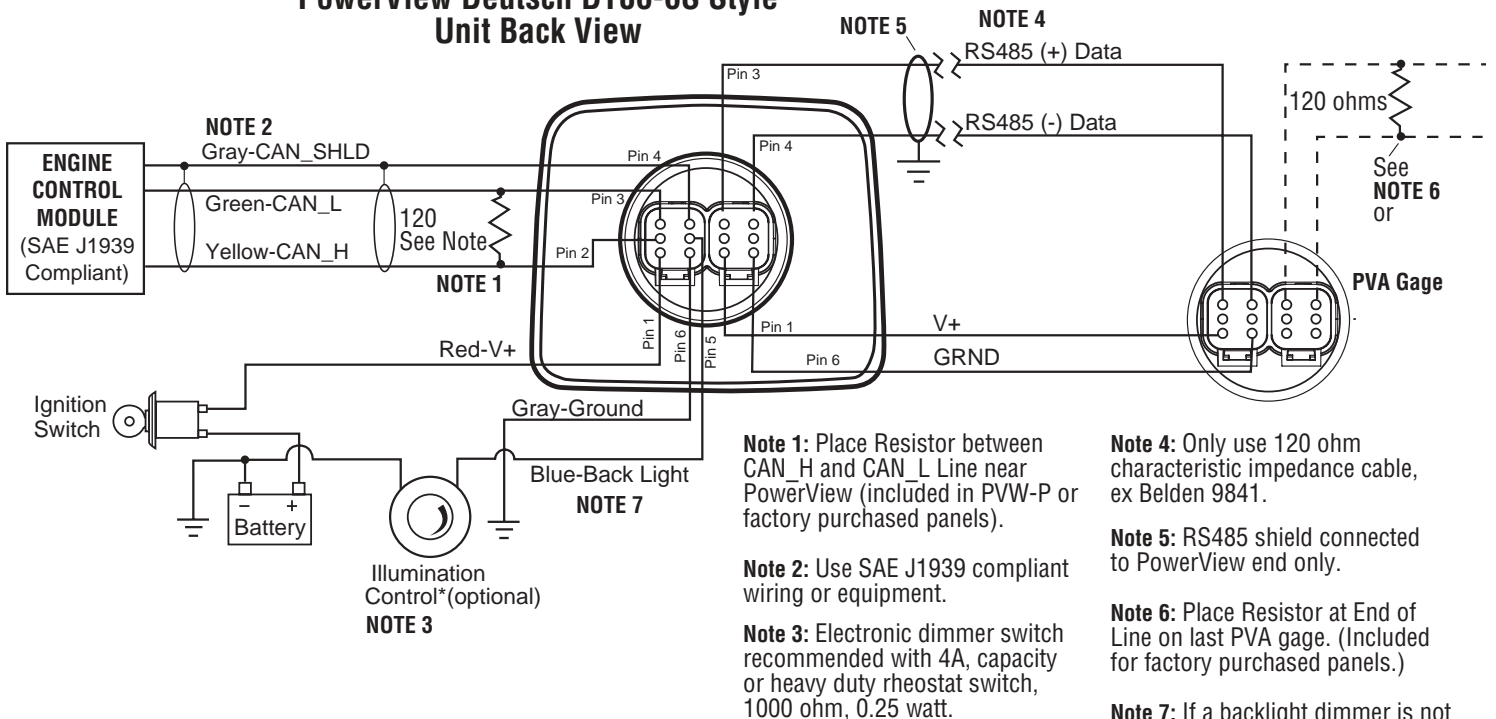

PowerView Menus

First Time Start Up

1. When power is first applied to the PowerView, the "Logo Screen" will be displayed.



2. The "Wait to Start" message will be displayed for engines with a pre-startup sequence. Once the "Wait to Start" message is no longer displayed the operator may start the engine. Note: Displays only when SAE J1939 message is supported by engine manufacturer.

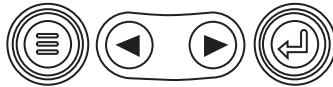

3. Once the engine has started the display will show the single engine parameter display.

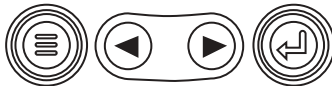
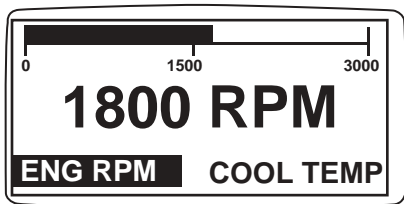

Main Menu Navigation

1. Starting at the single or four engine parameter display, depress the "Menu Button".

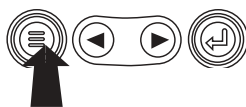
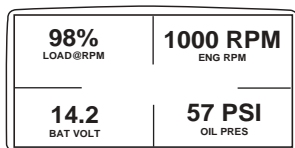
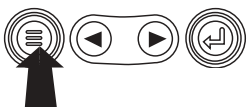
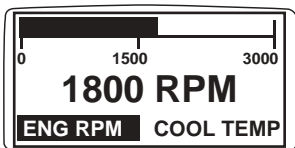

2. The first seven items of the "Main Menu" will be displayed.

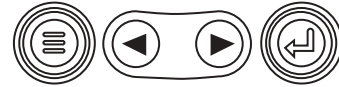
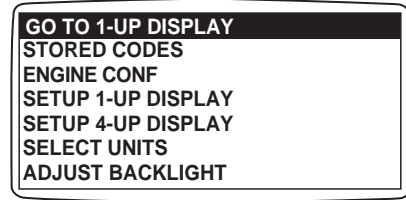

3. Depressing the "Arrow Buttons" will scroll through the menu selections.

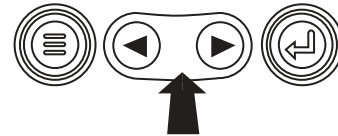
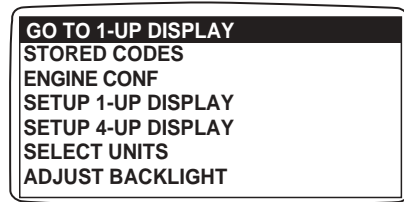

4. Pressing the right arrow button will scroll down to reveal the last items of "Main Menu" screen highlighting the next item down.

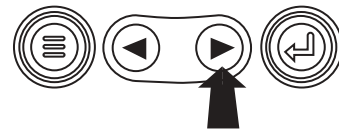
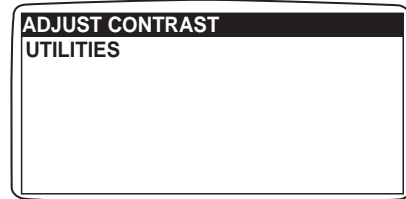

5. Use the arrow buttons to scroll to the desired menu item or press the "Menu Button" to exit the Main menu and return to the engine parameter display.

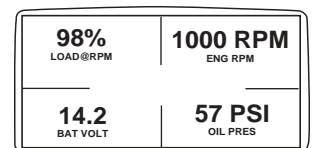
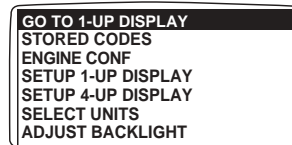

Stored Fault Codes

1. Starting at the single or four engine parameter display depress the "Menu Button".

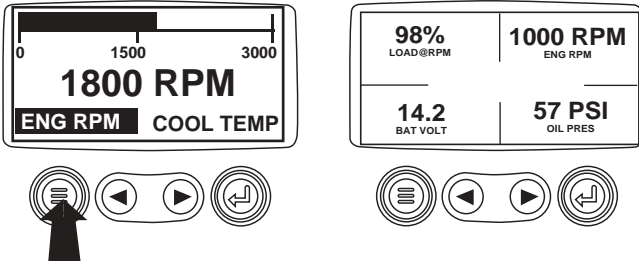

2. The main menu will pop up on the display. Use the "Arrow Buttons" to scroll through the menu until the "Stored Fault Codes" is highlighted.

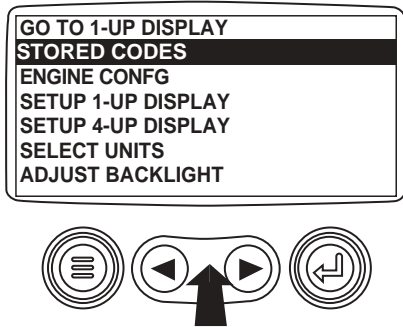

3. Once the "Stored Fault Codes" menu item has been highlighted press the "Enter Button" to view the "Stored Fault Codes".

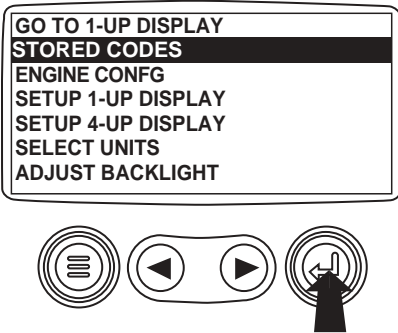

4. If the word "MORE" appears above the "Arrow Buttons" there are more stored fault codes that may be viewed. Use the "Arrow Buttons" to scroll to the next Stored Diagnostic Code.

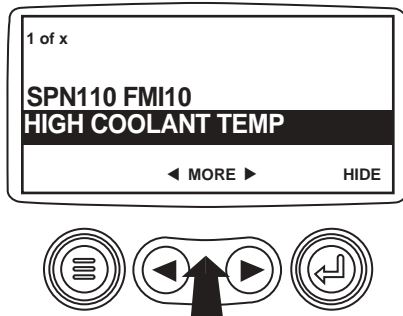

5. Press the "Menu Button" to return to the main menu.

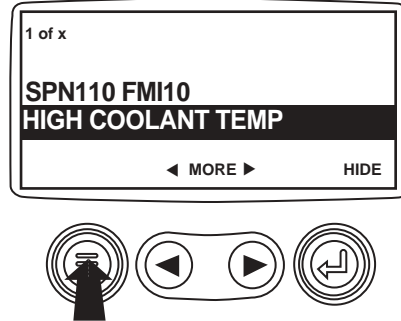

6. Press the "Menu Button" to exit the Main menu and return to the engine parameter display.

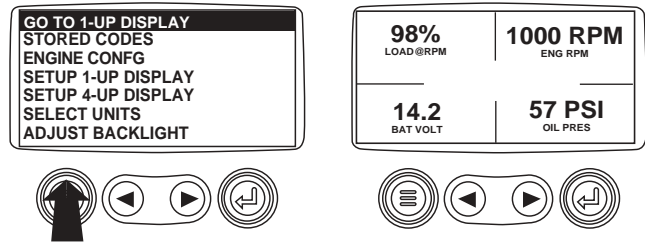

Engine Configuration Data

1. Starting at the single or four engine parameter display press the "Menu Button".

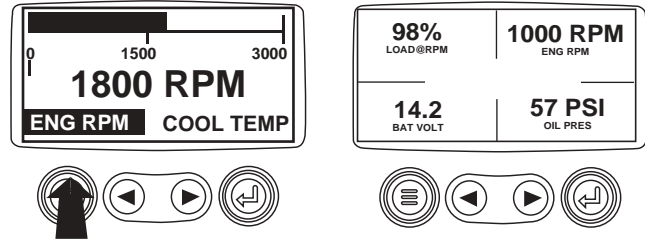

2. The main menu will pop up on the display. Use the "Arrow Buttons" to scroll through the menu until the "Engine Configuration" is highlighted.

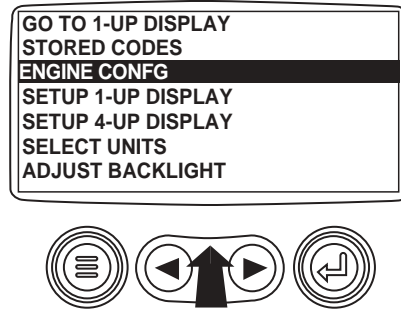

3. Once the "Engine Configuration" menu item has been highlighted press the "Enter Button" to view the engine configuration data.

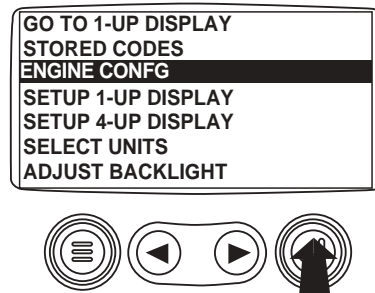

4. Use the "Arrow Buttons" to scroll through the engine configuration data.

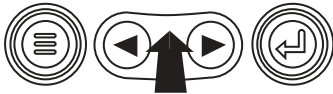
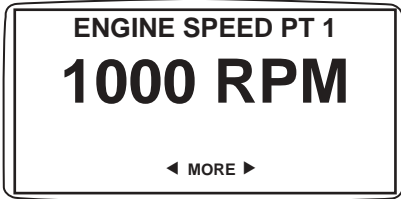

5. Press the "Menu Button" to return to the main menu.

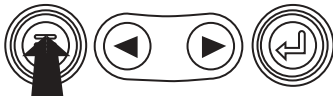
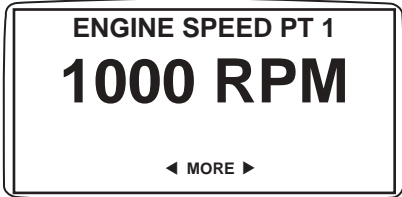

6. Press the "Menu Button" to exit the Main menu and return to the engine parameter display.

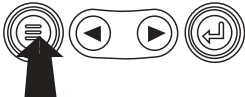
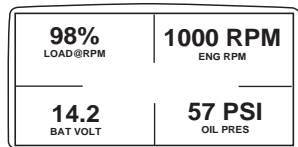
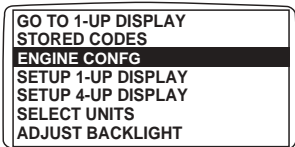

Faults and Warnings

Auxiliary Gage Fault

1. During normal operation the single or four parameter screen will be displayed.

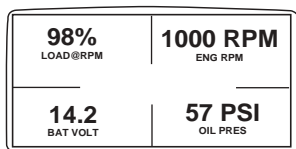
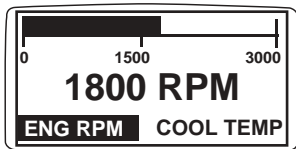

2. The PVA Series of auxiliary gages can be attached to the PowerView. These auxiliary gages communicate with the Modbus master PowerView via a daisy-chained RS-485 port. If at any time during system initialization

or normal operation an auxiliary gage should fail the single or four parameter screen will be replaced with the "MLink Gage Fault" message.

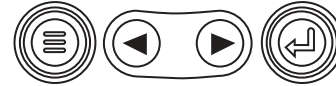

3. To acknowledge and "Hide" the fault and return to the single or four parameter display press the "Enter Button".

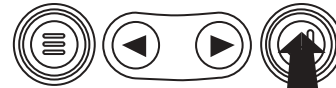

4. The display will return to the single or four parameter screen.

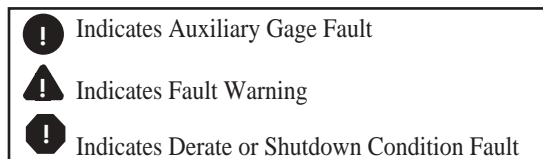
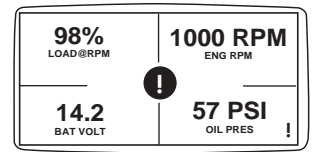
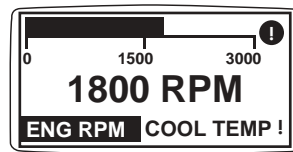

5. Pressing the "Enter Button" will redisplay the hidden fault. Pressing the "Enter Button" once again will hide the fault and return the screen to the single or four parameter display. NOTE: The fault can only be cleared by correcting the cause of the fault condition.



Active Fault Codes

1. During normal operation the single or four parameter screen will be displayed.

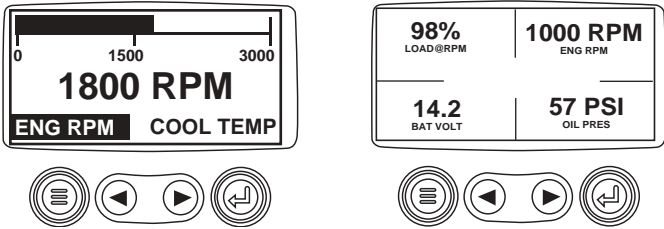

2. When the PowerView receives a fault code from an engine control unit the single or four parameter screen will be replaced with the "Active Fault Codes" message.

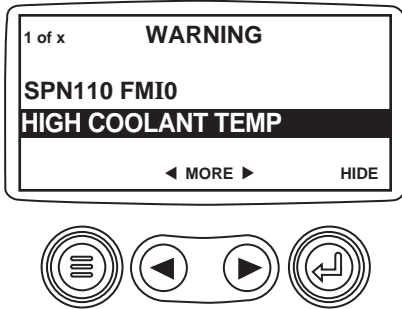

3. If the word "MORE" appears above the "Arrow Buttons" there are more active fault codes that may be viewed. Use the "Arrow Buttons" to scroll to the next "Active Fault Code"

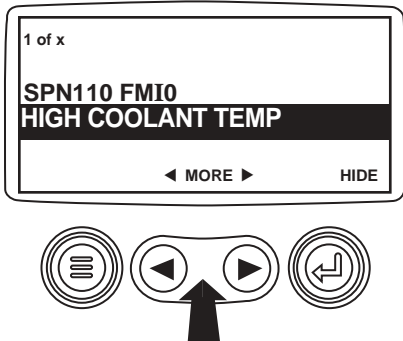

4. To acknowledge and "Hide" the fault and return to the single or four parameter display press the "Enter Button".

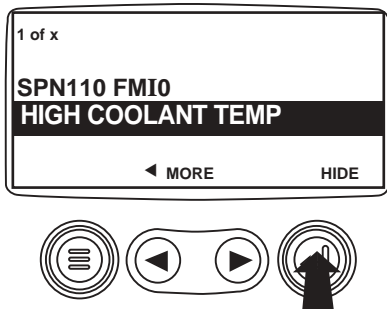

5. The display will return to the single or four parameter display, but the display will contain the "Active Fault" warning icon. Pressing the "Enter Button" will redisplay the hidden fault.

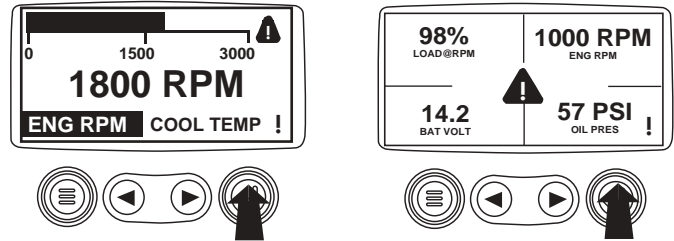

6. Pressing the "Enter Button" once again will hide the fault and return the screen to the single or four parameter display.

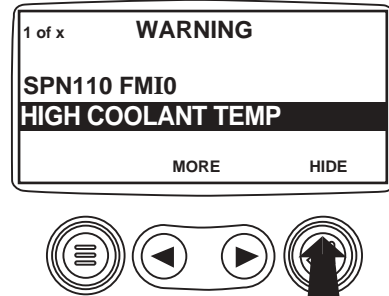

7. The Single or Four parameter screen will display the fault icon until the fault condition is corrected. NOTE: Ignoring active fault codes could result in severe engine damage.

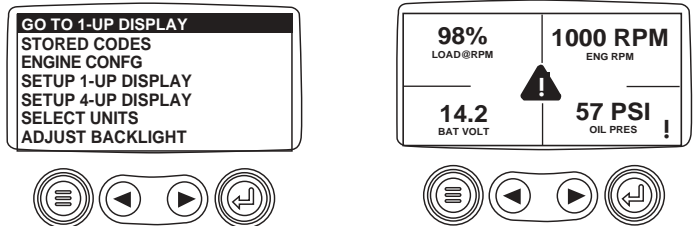

Shutdown Codes

1. During normal operation the single or four parameter screen will be displayed.

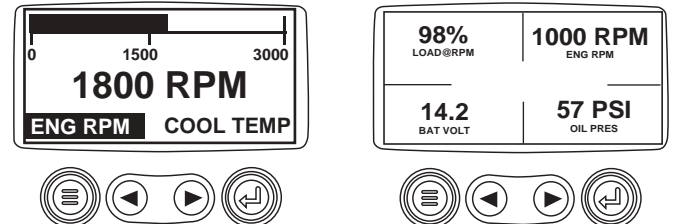

2. When the PowerView receives a severe fault code from an engine control unit the single or four parameter screen will be replaced with the "Shutdown!" message.

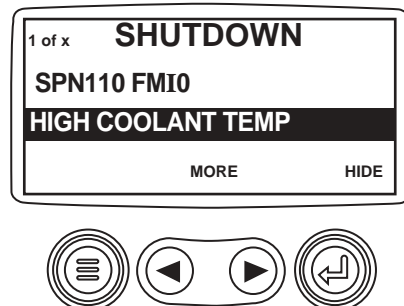

3. To acknowledge and "Hide" the fault and return to the single or four parameter display press the "Enter Button".

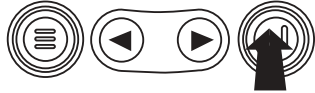
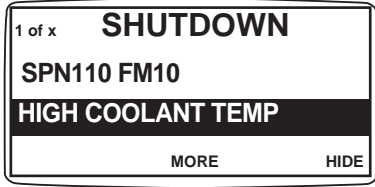

4. The display will return to the single or four parameter display, but the display will contain the "Shut Down" icon. Pressing the "Enter Button" will redisplay the hidden fault.



5. Pressing the "Enter Button" once again will hide the fault and return the screen to the single or four parameter display.

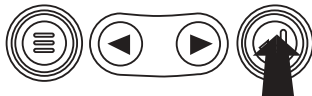
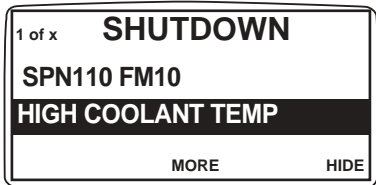

6. The Single or Four parameter screen will display the fault icon until the fault condition is corrected. NOTE: Ignoring active fault codes could result in severe engine damage.



Back Light Adjustment

1. Starting at the single or four engine parameter display press the "Menu Button".

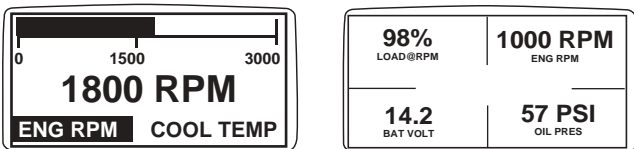

2. The main menu will pop up on the display. Use the "Arrow Buttons" to scroll through the menu until the "Adjust Backlight" is highlighted.

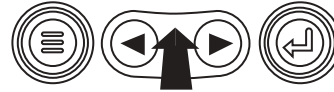
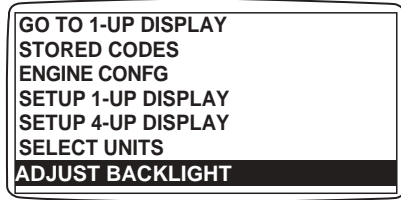

3. Once the "Adjust Backlight" menu item has been highlighted press the "Enter Button" to activate the "Adjust Backlight" function.

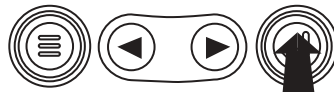
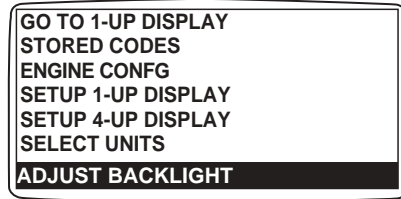

4. Use the "Arrow Buttons" to select the desired backlight intensity.

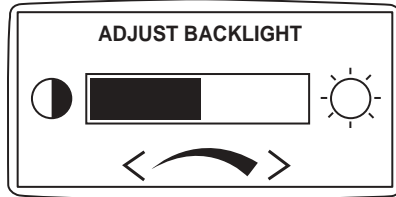

5. Press the "Menu Button" to return to the main menu.

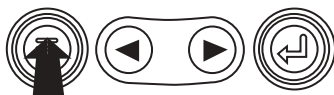
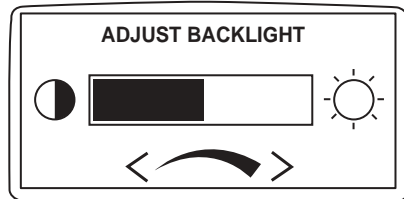

6. Press the "Menu Button" to exit the Main menu and return to the engine parameter display.

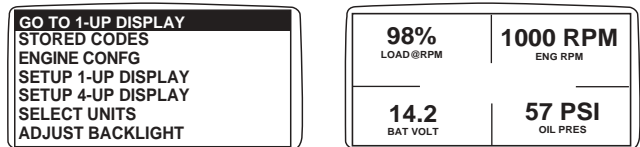

Contrast Adjustment

1. Starting at the single or four engine parameter display depress the "Menu Button".

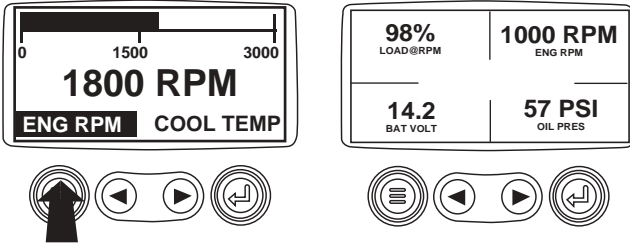

2. The main menu will pop up on the display. Use the "Arrow Buttons" to scroll through the menu until "Adjust Contrast" is highlighted.

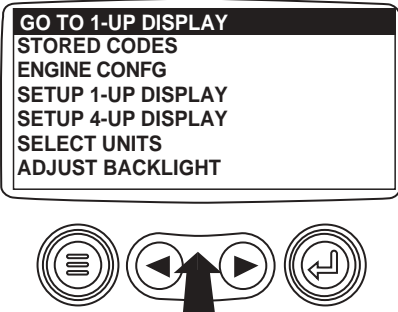

3. Once the "Adjust Contrast" menu item has been highlighted press the "Enter Button" to activate the "Adjust Contrast" function.

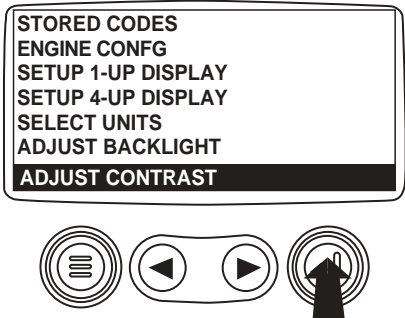

4. Use the "Arrow Buttons" to select the desired contrast intensity.

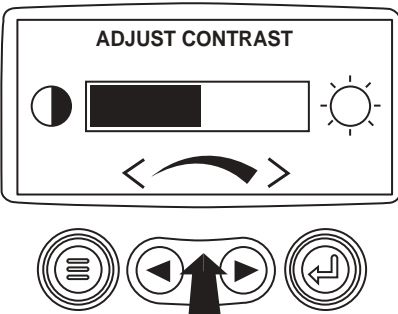

5. Press the "Menu Button" to return to the main menu.

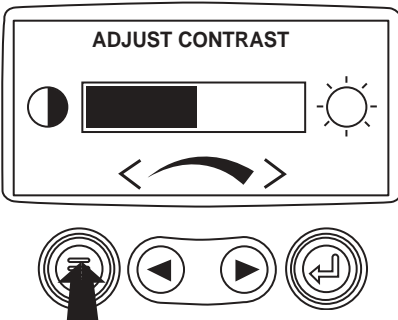

6. Press the "Menu Button" to exit the Main menu and return to the engine parameter display.

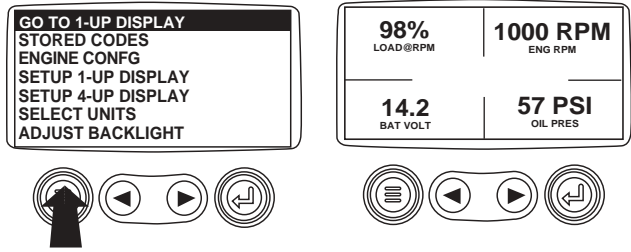

Select Units

1. Starting at the single or four engine parameter display depress the "Menu Button".

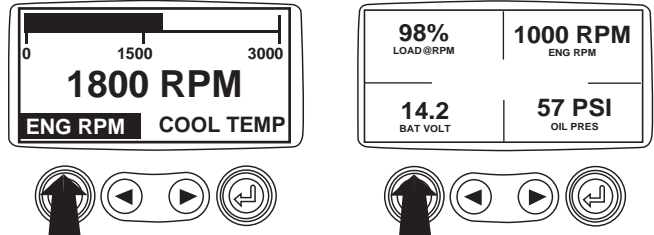

2. The main menu will pop up on the display. Use the arrow buttons to scroll through the menu until the "Select Units" is highlighted.

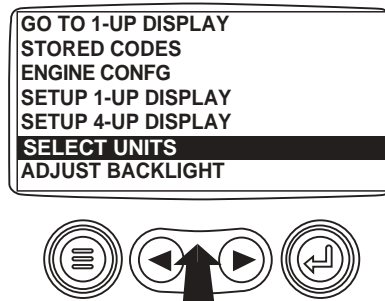

3. Once the "Select Units" menu item has been highlighted press the "Enter Button" to access the "Select Units" function.

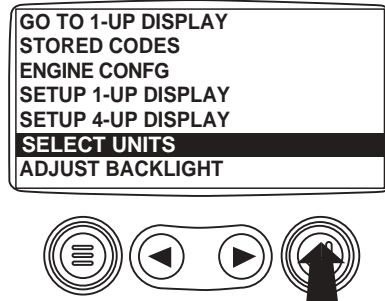

4. Use the arrows to highlight the desired units. "English" for Imperial units i.e. PSI, °F or Metric kPa, Metric Bar for IS units i.e. kPa, Bar, °C.

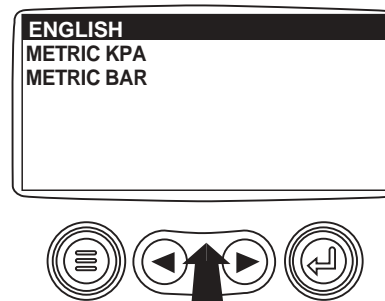

5. Press the "Enter Button" to select the highlighted units.

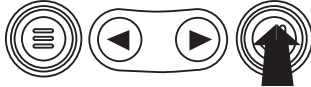
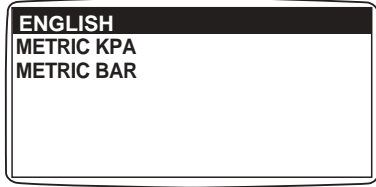

6. Press the "Menu Button" to return to the "Main Menu".

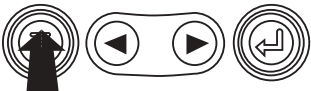
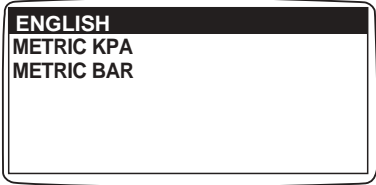

7. Press the "Menu Button" to exit the Main menu and return to the engine parameter display.

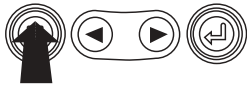
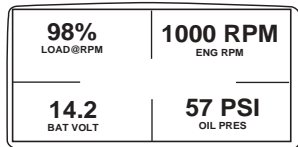
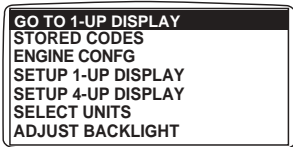

Setup 1-Up Display

1. Starting at the single engine parameter display press the "Menu Button".

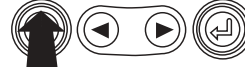
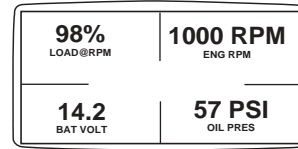
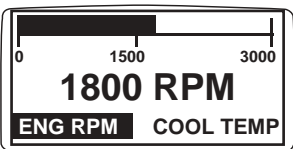

2. The main menu will pop up on the display. Use the "Arrow Buttons" to scroll through the menu until the "Setup 1-up Display" is highlighted.

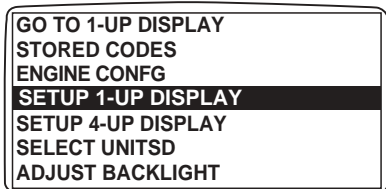

3. Once the "Setup 1-up Display" menu item has been highlighted press the "Enter Button" to access the "Setup 1-up Display" function.

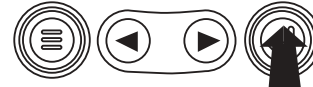
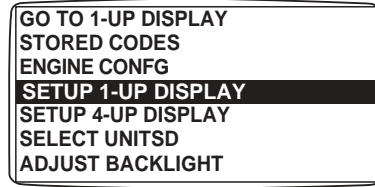

4. Three options are available for modification of the 1-Up display.

- a). **Use Defaults** – This option contains a set of engine parameters: Engine Hours, Engine RPM, System Voltage, Battery Voltage, % Engine Load at Current RPM, Coolant Temperature, Oil Pressure.
- b). **Custom Setup** – This option allows for the modification of what parameter, the number of parameters, and the order in which the parameters are being displayed.
- c). **Automatic Scan** – Selecting the scan function will cause the 1-Up Display to scroll through the selected set of parameters one at a time, momentarily pausing at each.

5. **Use Defaults** - To select "Use Defaults" use the arrow buttons to scroll to and highlight "Use Defaults" in the menu display.

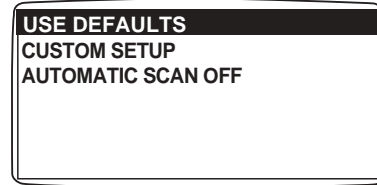

6. Press the "Enter Button" to activate the "Use Defaults" function.

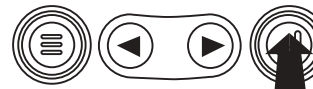
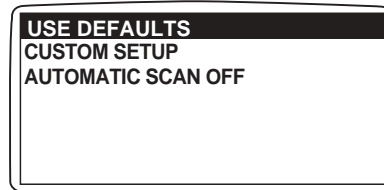

7. A message indicating the "Single Engine" parameter display parameters are reset to the factory defaults will be displayed, then the display will return to the "Custom Setup" menu.

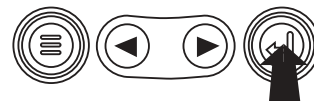

8. Custom Setup - To perform a custom setup of the 1-Up Display use the arrow buttons to scroll to and highlight "Custom Setup" on the display.

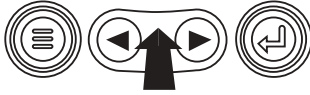
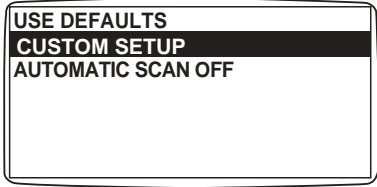

9. Pressing the "Enter Button" will display a list of engine parameters.

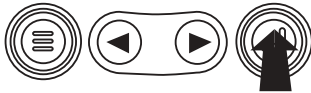
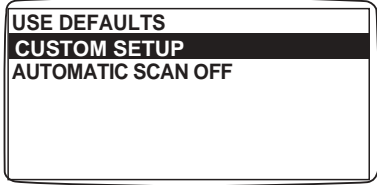

10. Use the "Arrow Buttons" to scroll to and highlight a selected parameter (parameter with a # symbol to right of it).

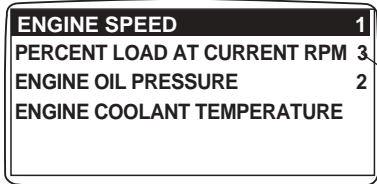

This number indicates the order of display for the parameters and that the parameter is selected for display.



11. Press the "Enter Button" to disselect the selected parameter removing it from the list of parameters being displayed on the 1-up display.

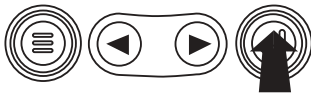
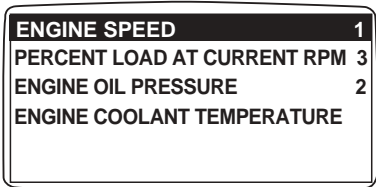

12. Use the "Arrow Buttons" to scroll and highlight the desired parameter that has not been selected for display.

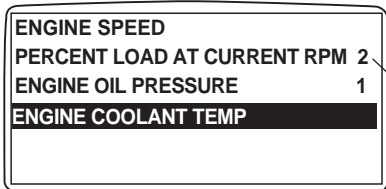

Note that the numbers now indicate the new order of display for the parameters.



13. Press the "Enter button" to select the highlighted parameter for inclusion in the Single Engine Parameter Display.

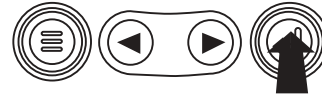
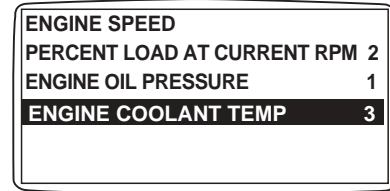

14. Continue to scroll and select additional parameters for the custom 1-Up Display. Press the "Menu button" at any time to return to the "Custom Setup" menu.

15. Automatic Scan - Selecting the scan function will cause the 1-Up Display to scroll through the selected set of parameters one at a time. Use the "Arrow Buttons" to scroll to the "Automatic Scan" function.

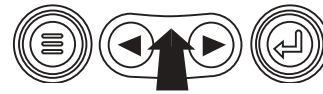
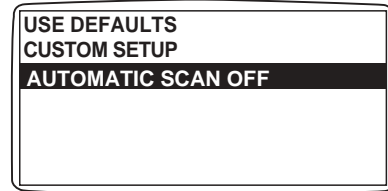

16. Pressing the "Enter Button" toggles the "Automatic Scan" function on.

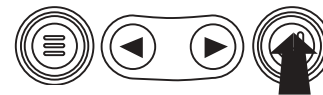
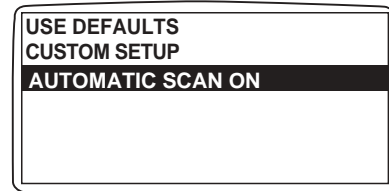

17. Pressing the "Enter Button" again toggles the "Automatic Scan" function off.

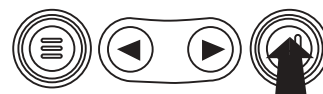
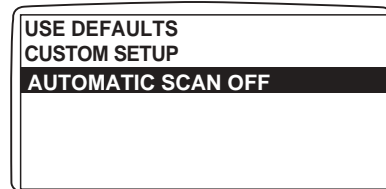

18. Once the "Use Defaults", "Custom Setup" and "Automatic Scan" functions have been set press the "Menu Button" to return to the main menu.

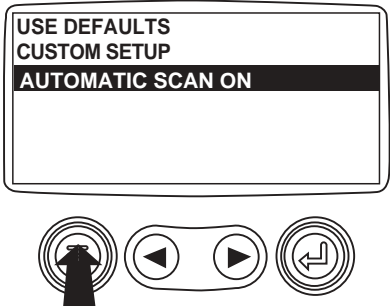

19. Press the "Menu Button" to exit the Main menu and return to the engine parameter display.

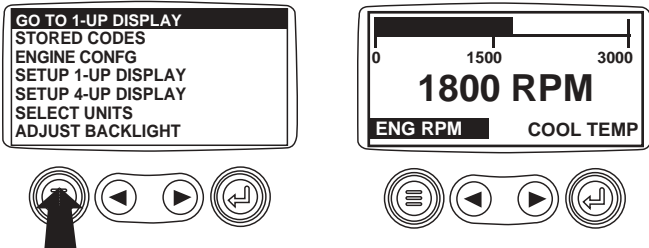

Setup 4-Up Display

1. From the single or four engine parameter display press the "Menu Button".

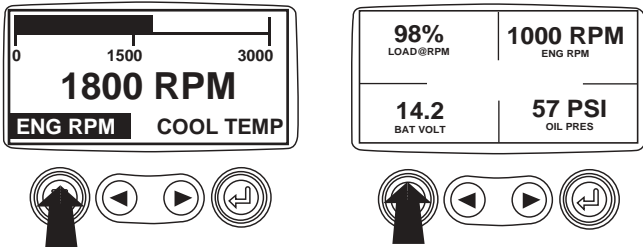

2. The main menu will pop up on the display. Use the "Arrow Buttons" to scroll through the menu until the "Setup 4-Up Display" is highlighted.

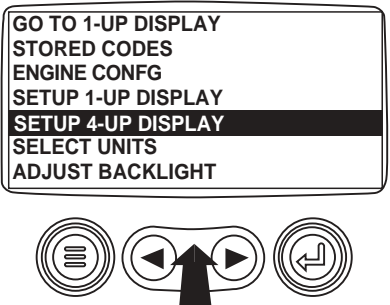

3. Once the "Setup 4-Up Display" menu item has been highlighted press the "Enter Button" to activate the "Setup 4-Up Display" menu.

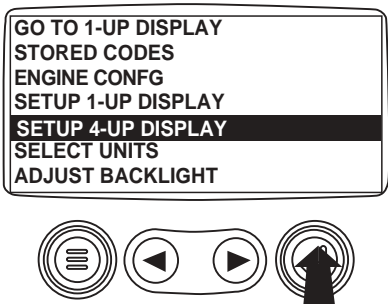

4. Press the "Enter Button" to activate the "Use Defaults" function. This action will reset the unit to the factory default.

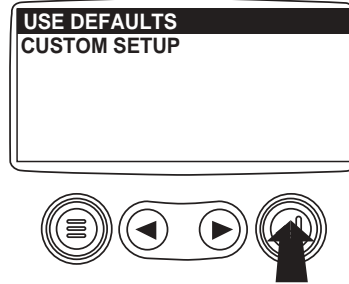

5. The "Use Defaults" screen will be displayed during the resetting period then will automatically return to the "Setup 4-Up Display" menu.

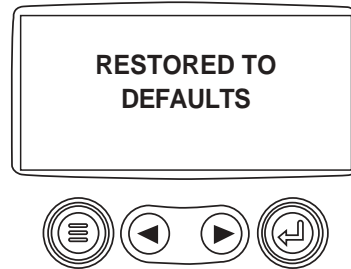

6. Select the "4-Up Custom Setup" from the "4-Up Setup" menu.

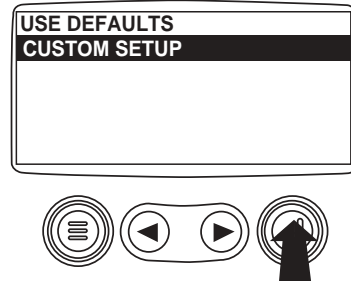

7. The quadrant with the backlit parameter value is the current selected parameter. Use the "Arrow Buttons" to highlight the parameter value in the quadrant you wish to place a new parameter.

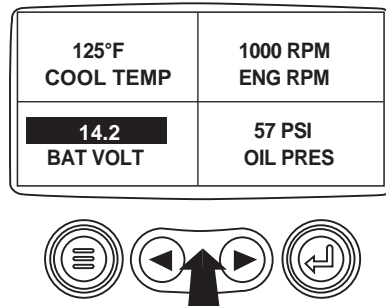

8. Press the "Enter Button" and a list of parameters will appear.

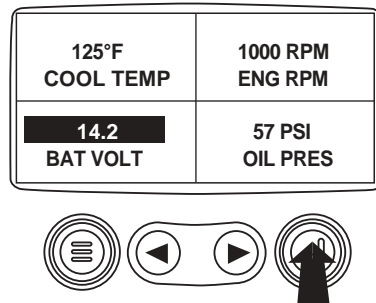

9. The parameter that is highlighted is the selected parameter for the screen. Use the "Arrow Buttons" to highlight the new parameter to be placed in the quadrant selected in the previous screen.

ENGINE SPEED	3
ENGINE HOURS	
ENGINE COOLANT TEMPERATURE	1
BATTERY POTENTIAL	
ENGINE OIL TEMPERATURE	2
ENGINE OIL PRESSURE	4

The number to the right of the parameter indicates the quadrant in which it is displayed.
 1. = Upper Left Quadrant
 2. = Lower Left Quadrant
 3. = Upper Right Quadrant
 4. = Lower Right Quadrant

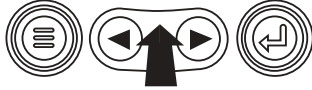

10. Press the "Enter Button" to change the selected parameter in the quadrant to the new parameter.

ENGINE SPEED	3
ENGINE HOURS	
ENGINE COOLANT TEMPERATURE	1
BATTERY POTENTIAL	2
ENGINE OIL TEMPERATURE	
ENGINE OIL PRESSURE	4

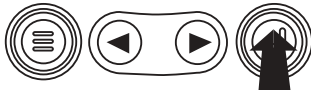

11. Use the "Menu Button" to return to the "4-UP Custom Setup" screen.

ENGINE SPEED	3
ENGINE HOURS	
ENGINE COOLANT TEMPERATURE	1
BATTERY POTENTIAL	
ENGINE OIL TEMPERATURE	2
ENGINE OIL PRESSURE	4

Note the number to the right of the selected parameter indicating that the parameter is now assigned to that display location.

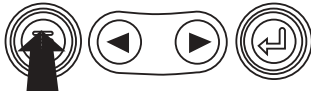

12. The parameter in the selected quadrant has changed to the parameter selected in the previous screen.

125°F COOL TEMP	1000 RPM ENG RPM
143°F OIL TEMP	57 PSI OIL PRES

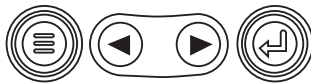

13. Repeat the parameter selection process until all spaces are filled.

14. Press the "Menu Button" to return to the main menu.

125°F COOL TEMP	1000 RPM ENG RPM
143°F OIL TEMP	57 PSI OIL PRES

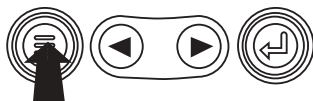

15. Press the "Menu Button" to exit the Main menu and return to the engine parameter display.

GO TO 1-UP DISPLAY
STORED CODES
ENGINE CONFG
SETUP 1-UP DISPLAY
SETUP 4-UP DISPLAY
SELECT UNITS
ADJUST BACKLIGHT

125% COOL TEMP	1000 RPM ENG RPM
143°F OIL TEMP	57 PSI OIL PRES

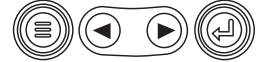
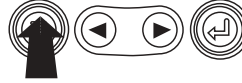

Utilities (Information and troubleshooting)

1. Starting at the single or four engine parameter display, press the "Menu button"

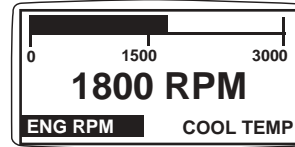

125% COOL TEMP	1000 RPM ENG RPM
143°F OIL TEMP	57 PSI OIL PRES

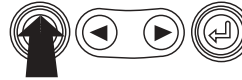

2. The main menu will be displayed. Use the "Arrow buttons" to scroll through the menu until the "Utilities" is highlighted.

STORED CODES
ENGINE CONFG
SETUP 1-UP DISPLAY
SETUP 4-UP DISPLAY
SELECT UNITS
ADJUST BACKLIGHT
UTILITIES



3. Once the "Utilities" menu item has been highlighted, press the "Enter Button" to activate the "Utilities" functions.

STORED CODES
ENGINE CONFG
SETUP 1-UP DISPLAY
SETUP 4-UP DISPLAY
SELECT UNITS
ADJUST BACKLIGHT
UTILITIES



4. Press "Select" to enter the "Gages Data" display. When "Gage Data" is selected the PowerView will communicate with the analog gages at a fixed rate of 38.4 k Baud, 8 data bits, no parity check, 1 stop bits, half duplex.

GAGE DATA
REMOVE ALL GAGES
SOFTWARE VERSION
FAULT CONVERSION

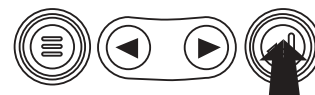

5. Use the “Arrow buttons” to scroll through the items or press “Menu” to return to the “Utilities” menu.

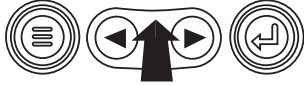
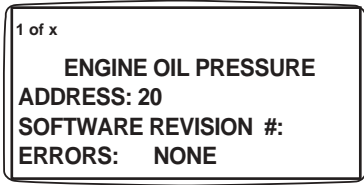

6. Press “Menu Button” to return to the “Utilities” menu.

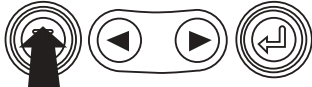
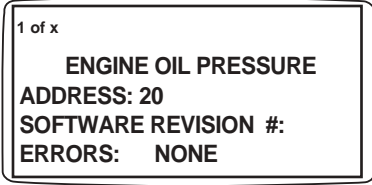

7. Use the “Arrows” to highlight “Remove All Gages”. Press “Select” to clear gage data from memory. It takes a moment to clear all gages.

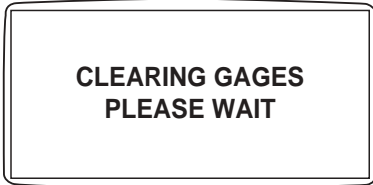

8. When the gage data has cleared, the display automatically returns to the “Utilities” menu. Scroll to “Software Version”. Press “Select” to view the software version currently in the PowerView.

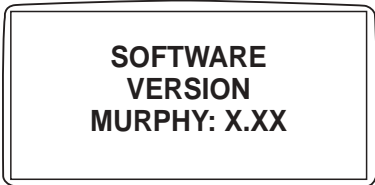

9. Press “Menu” to return to “Utilities”. Highlight “Fault Conversion” using the “Arrows”. Press “Select” to enter the Fault conversion menu.

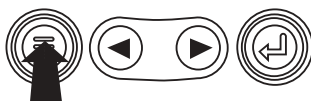
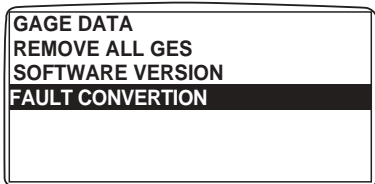

11. Using the “Arrow” buttons scroll to highlight the version to be selected. Press the “Select” button to select the version. Note that an asterisks appears to the right of the selection.

NOTE: There are four (4) different methods for converting fault codes. The PowerView always looks for J1939 Version 4 and can be set to use one of the three (3) other J1939 versions. Most engine ECU’s use Version 4, therefore in most cases adjustment of this menu option will not be required.

Upon receiving an unrecognizable fault, change to a different J1939 Version. If the fault SPN does not change when the version is changed, the ECU generating the fault is using Fault Conversion method 4. If the SPN number does change but is still unrecognizable, try changing to another J1939 Version not yet used and continue to check the SPN number.

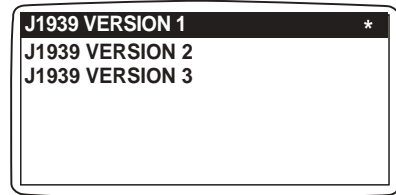

12. Press the “Menu” button to return to “Utilities” menu. Press the “Menu” button again to return to the “Main” menu.

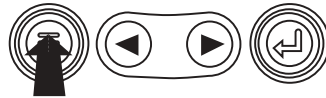
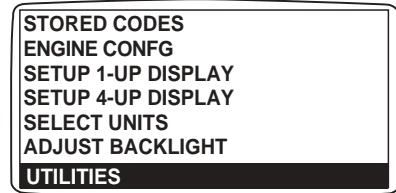

SAE J1939 MurphyLink System Implementation of J1939 Parameters

Source: SAEJ1939-71 Surface Vehicle Recommended Practice

SAE J1939 Section	Description	PGN	Parameter	Display Value
5.3.6	Elec Eng Cont #2 - EEC2	61443	Accelerator Pedal Position	THROTTLE
			Percent Load at Current RPM	LOAD@RPM
5.3.7	Elec Eng Cont #1 - EEC1	61444	Actual engine % torque	ENG TORQUE
			Engine Speed	ENG RPM
5.3.14	Vehicle Distance	65248	Trip Distance	TRIPSPDIST
			Total Vehicle Distance	VEH DIST
5.3.19	Engine hours, Revolutions	65253	Total Engine Hours	ENG HRS
5.3.23	Fuel Consumption	65257	Trip Fuel	TRIP FUEL
			Total Fuel Used	FUELUSED
5.3.28	Engine Temperature	65262	Engine Coolant Temp	COOL TEMP
			Fuel Temperature	FUEL TEMP
			Engine Oil Temperature	OIL TEMP
			Engine Intercooler Temperature	INTC TEMP
5.3.29	Engine Fluid Level/Pressure	65263	Fuel Delivery Pressure	FUEL PRES
			Engine Oil Level	OIL LVL
			Engine Oil Pressure	OIL PRES
			Coolant Pressure	COOL PRES
			Coolant Level	COOL LVL
5.3.31	Cruise Control /Vehicle Speed	65265	Wheel Based Vehicle Speed	VEH SPD
5.3.32	Fuel Economy	65266	Fuel Rate	FUEL RATE
			Instantaneous Fuel Economy	FUEL ECON
			Average Fuel Economy	AVG ECON
5.3.35	Ambient Conditions	65269	Barometric Pressure	BARO PRES
			Air Inlet Temperature	AIR IN TEMP
5.3.36	Inlet/Exhaust Conditions	65270	Boost Pressure	BST PRES
			Intake Manifold Temp	MANI TMP
			Air Filter Differential Pressure	AIRDIFPR
			Exhaust Gas Temperature	EXH TEMP
5.3.37	Vehicle Electrical Power	65271	Alternator Voltage	ALT VOLT
			Electrical Potential (Voltage)	SYS VOLT
			Battery Pot. Voltage (Switched)	BAT VOLT
5.3.8	Electronic Transmission Controller #2	61445	Selected Gear	SELECT GEAR
		61445	Current Gear	CURNT GEAR
5.3.38	Transmission Fluids	65272	Transmission Oil Pressure	TRAN PRES
			Transmission Oil Temperature	TRAN TEMP
5.3.46	Engine Fluid Level/Pressure #2	65243	Injector Metering Rail 1 Pres	INJ PRES1
			Injector Metering Rail 2 Pres	INJ PRES2
5.3.58	Fan Drive	65213		FAN SPD
5.3.111	Auxiliary Pressures & Temperatures	65164	Auxiliary Temperature	AUX TEMP
			Auxiliary Pressure	AUX PRES
	Diagnostic Messages	65226	DM1 - Active Diagnostic	SRVCCODE
		65227	DM2 - Previously Act Diag Codes	STORCODE
		65228	DM3 - Diagnostic Clear	
J1939 N/A	Machine Hours (PowerView Calculated)	N/A	Machine Hours	MACH HRS
5.3.17	Engine Conf.	65251	Engine Configuration	ENG CONF
5.3.5	Electronic Transmission Controller #1	61442	Output Shaft Speed	OUT SFT SPD
	Electronic Transmission Controller #1	61442	Input Shaft Speed	IN SFT SPD
	Electronic Transmission Controller #1	61442	Torque Converter Lockup Engaged	TORQ LOCK

GLOSSARY (Troubleshooting information)

CANBUS FAILURE

PowerView has not received any CAN messages for at least 30 seconds.

NO DATA

PowerView has not received the particular message being displayed for at least 5 seconds.

NOT SUPPORTED

PowerView has received a message from the ECU stating the displayed message is not supported.

DATA ERROR

PowerView has received an error message from the ECU for the displayed message.

EMPTY

No parameter selected for this 4-UP quadrant.

WAIT TO START PREHEATING

This is a message from the engine indicating it is in a preheating cycle. Wait until this message clears before starting the engine.

TIMEOUT ECU NOT RESPONDING

The ECU did not respond to the PowerView request.

NO GAGE DATA

The PowerView has no record of connected gages to the RS485 bus.



FWMurphy

P.O. Box 470248
Tulsa, Oklahoma 74147 USA
+1 918 317 4100
fax +1 918 317 4266
e-mail sales@fwmurphy.com
www.fwmurphy.com

CONTROL SYSTEMS & SERVICES DIVISION

P.O. Box 1819; Rosenberg, Texas 77471; USA
+1 281 633 4500 fax +1 281 633 4588
e-mail sales@fwmurphy.com

MURPHY DE MEXICO, S.A. DE C.V.

Bld. Antonio Rocha Cordero 300, Fracción del Aguaaje
San Luis Potosí, S.L.P.; México 78384
+52 444 8206264 fax +52 444 8206336
Villahermosa Office +52 993 3162117
e-mail ventas@murphymex.com.mx
www.murphymex.com.mx

FRANK W. MURPHY, LTD.

Church Rd.; Laverstock, Salisbury SP1 1QZ; U.K.
+44 1722 410055 fax +44 1722 410088
e-mail sales@fwmurphy.co.uk
www.fwmurphy.co.uk

MURPHY SWITCH OF CALIFORNIA

41343 12th Street West
Palmdale, California 93551-1442; USA
+1 661 272 4700 fax +1 661 947 7570
e-mail sales@murphyswitch.com
www.murphyswitch.com

MACQUARRIE CORPORATION

1620 Hume Highway
Campbellfield, Vic 3061; Australia
+61 3 9358 5555 fax +61 3 9358 5558
e-mail murphy@macquarrie.com.au



In order to consistently bring you the highest quality, full featured products, we reserve the right to change our specifications and designs at any time.

Printed in U.S.A.